

Roly Poly Snowmen

TABLE TOPPER

as featured on our YouTube channel:

 [YouTube.com/ShabbyFabrics](https://www.youtube.com/ShabbyFabrics)

Finishes to approximately 23½" × 23½"



FABRIC REQUIREMENTS

- ¼ yard **each** of **six** fabrics
- ⅓ yard cream tonal for **side setting triangles**
- ¼ yard for **binding**
- ⅔ yard for **backing**
- Creative Grids 60° Diamond Ruler # CGR60DIA

RECOMMENDED PRODUCTS

- Olfa Spinning Rotary Mat 17" × 17"
- Olfa Splash Rotary Cutter
- Clover Patchwork Pins
- Clover Magnetic Pin Caddy
- 50 wt. Cotton Thread in Off White (KT101)
- Shabby Fabrics Rectangle Ruler
- FriXion pen
- Erasable Fabric Marker - White
- Purple Thang
- Wool Pressing Mat
- Panasonic Cordless Iron

All available at [ShabbyFabrics.com](https://www.ShabbyFabrics.com)

PREPARE DIAMOND SECTIONS

From **each** of **six** fabrics, cut:

- (2) 1½" × WOF strips

Sew strips together to make (2) strip units, staggering the ends. Press seams open.

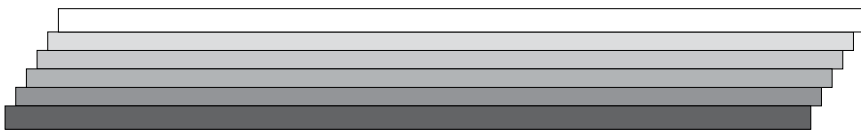

Aligning the lower edge of the 60° Diamond Ruler with the bottom edge of your strip unit, trim selvages off.

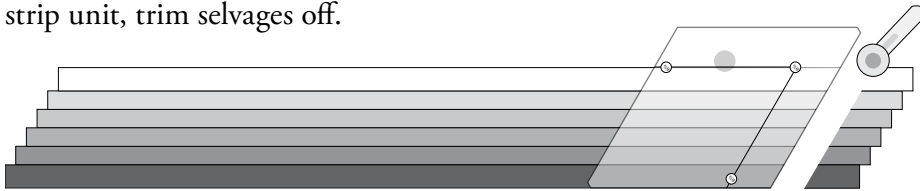

Rotate strip unit. Line up 6½" mark on ruler with the lower left corner of your strip unit, and cut diamond along the edge of the ruler. Trim tip of diamond to match ruler. Cut a total of (6) diamonds. (*This will require using the second strip unit.*)

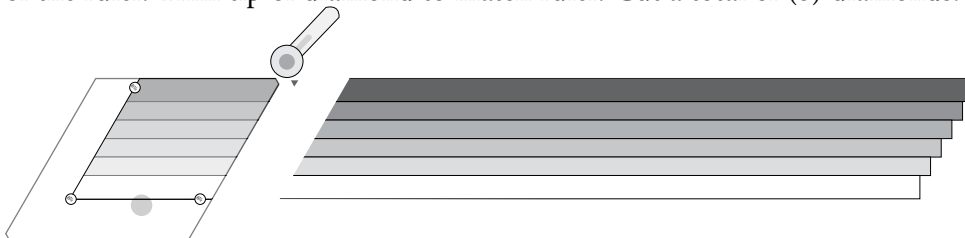

ASSEMBLE DIAMONDS

Arrange three diamonds as shown. Flip right diamond over center diamond so they are Right Sides Together (RST). Mark $\frac{1}{4}$ " from outer edge as shown. Starting at the center point, sew to the marked line, and backstitch several stitches at the end. **Do not sew past the drawn line!** Open and press seam toward white. Repeat with left diamond to complete one half of the star.

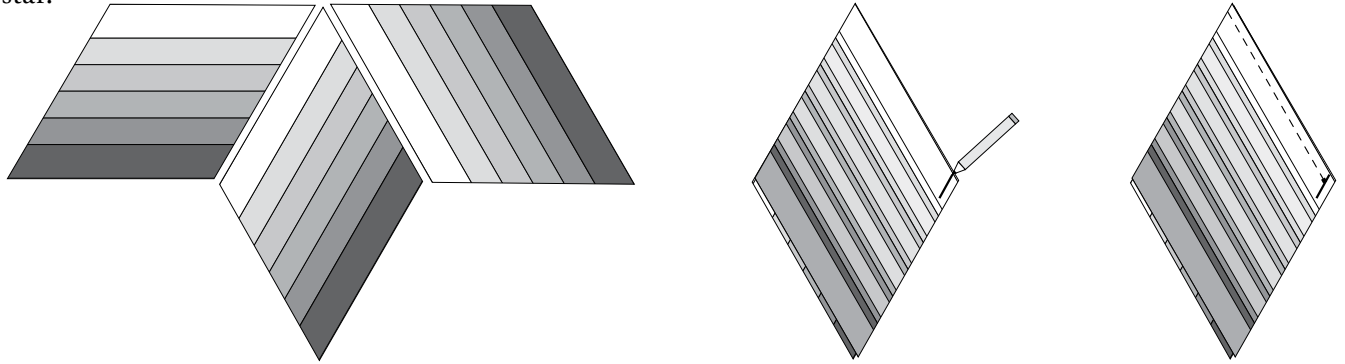

Repeat instructions above to make a second half.

Place halves RST, nesting center seams, and pin. Mark $\frac{1}{4}$ " start and stop points as shown. Stitch halves together, starting and stopping at marked lines, backstitching several stitches at each end. **Do not sew past the drawn lines!** Press seam open.

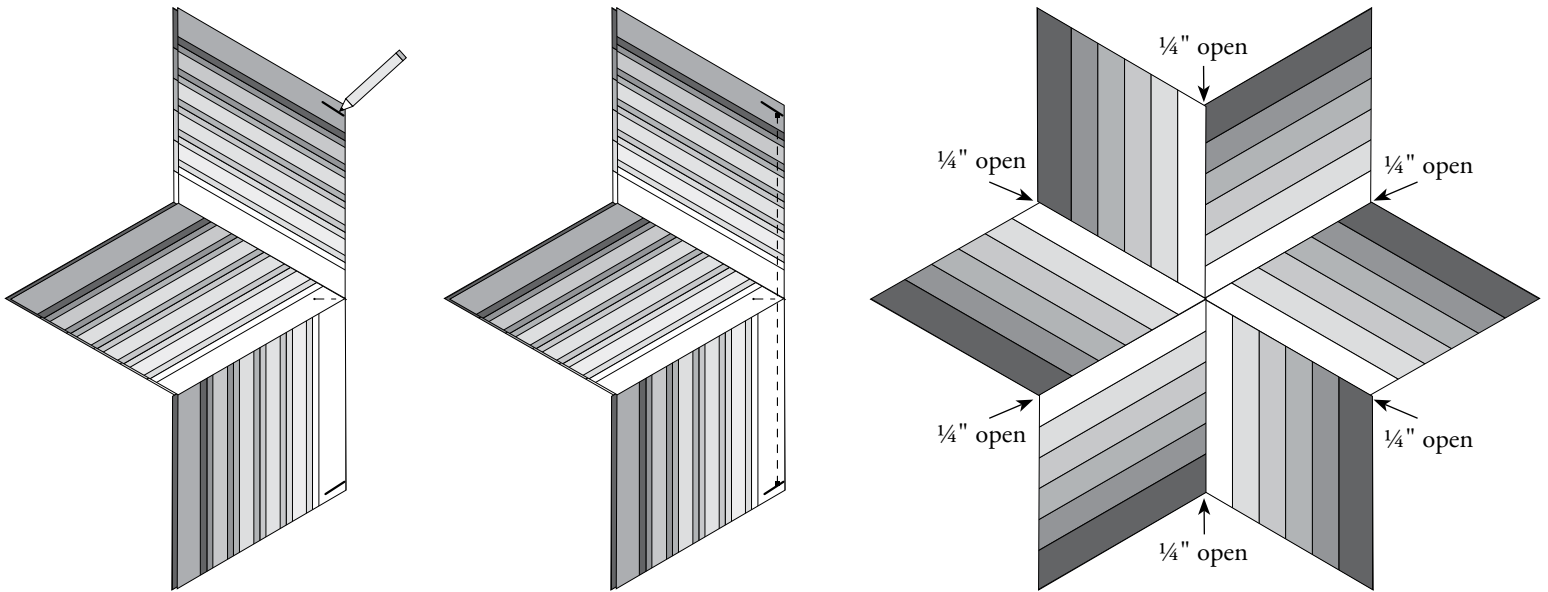

CUT SIDE SETTING TRIANGLES

From cream tonal fabric, cut:

- (2) $4\frac{1}{4}$ " \times WOF strips

Place one folded strip on cutting mat. Line up 60° Diamond Ruler with bottom of fabric on the **dashed line below** the $6\frac{1}{2}$ " SST mark. Cut along both sides of diamond. This will yield two side setting triangles. Unfold fabric, press, and cut a third side setting triangle. Repeat with second strip for a total of (6) side setting triangles.

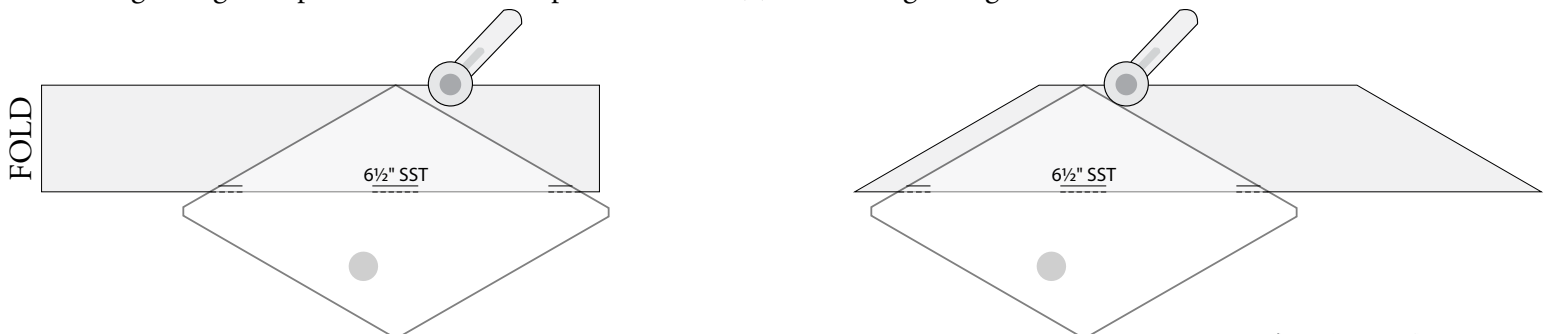

ADD SIDE SETTING TRIANGLES

Arrange star unit and one side setting triangle as shown (right). Fold the upper left star point toward the center, and flip the corner setting triangle so it lies right sides together on the star unit. Align 120° corner of side setting triangle with raw edges of the white strip. Pin in place.

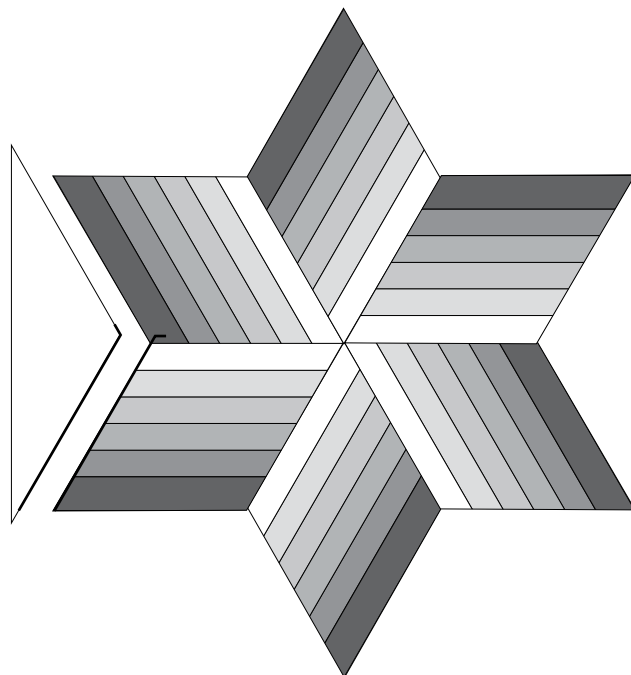

Because you will be starting at the center point, you will be sewing with the side setting triangle **DOWN**. *Skip the first ¼"*, which will be at the seam line of the diamond intersection. Starting at the center of the star unit, backstitch a few stitches at the beginning, and sew to the outer point. Press seam toward side setting triangle.

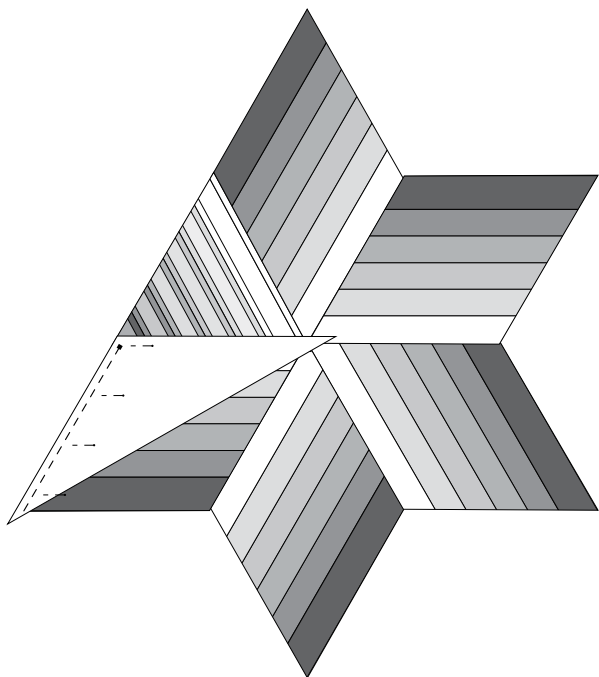

Arrange star unit as shown (right), and align 120° corner of side setting triangle with raw edge of the dark strip. Pin in place.

Sew with the side setting triangle **DOWN**. *Skip the first ¼"*, which will be at the seam line of the diamond intersection. Starting at the center of the star unit, backstitch a few stitches at the beginning, and sew to the outer point. Press seam toward side setting triangle.

Repeat with 5 remaining side setting triangles.

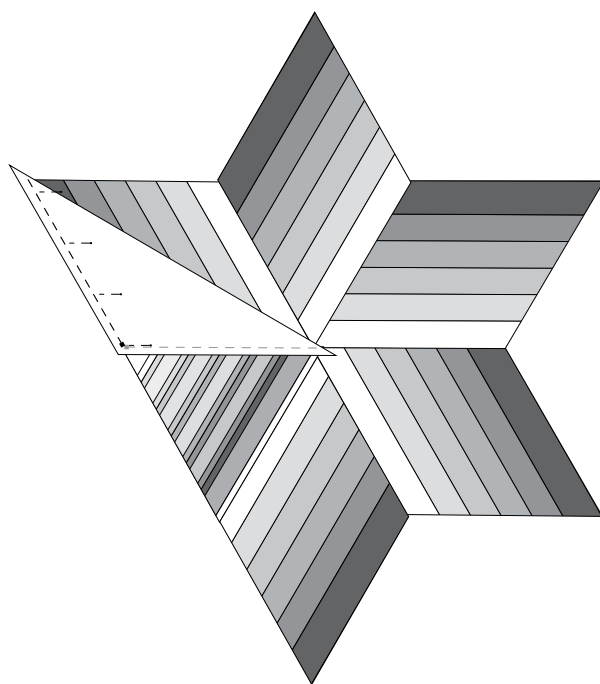

FINISH THE TABLE TOPPER

Layer table topper top, batting, and backing. Quilt as desired. Trim edges to ¼" past the point of each diamond.

From **binding** fabric, cut (2) 2½" × WOF strips.

Sew the binding strips into one long strip. Fold binding in half lengthwise with wrong sides together and press. Sew the binding to the front side of the table topper starting at any side. Turn the binding over the edge and machine stitch or hand sew to the back of the table topper.